



HTM-H043A10-MIPI-A06

产品名称 (Product name) : MIPI 接口 TFT 液晶模块
型号 (Model) : HTM-H043A10-MIPI-A06
编号 (Part number) : 20230614001
日期 (Date) : 2023-6-14

深圳市鑫洪泰电子科技有限公司

Shenzhen Hot Display Technology Co.,Ltd

编制 Prepared by	审核 Checked by	核准 Approved by
	受控文件 Y/ M/ D/	

编码: QR-R-011 A/0

序号:

Rev	Descriptions	Date
01	Prelimiay Release	2023-6-14



鑫洪泰

HOT DISPLAY

为您提供专业的显示解决方案

HTM-H043A10-MIPI-A06

鑫洪泰 光电

1. Basic Specifications

No.	Item	Specification	Unit	Remark
1	LCD Size	4.3" (Diagonal)	inch	-
2	Panel Type	a-Si TFT active matrix	-	-
3	Resolution	800x(3RGB)x480	pixel	-
4	Display Mode	Normally Black, Transmissive	-	-
5	Viewing Direction	All direction	-	-
6	Luminance	500	cd/m ²	-
7	Module Size	105.5(W) ×67.2(H) ×7.8(D)	mm	Note 1
8	Weight	TBD	g	-
9	Driver IC	MIPI-RGB Bridge	-	-
12	Light Source	2x5 White LEDs	-	-
13	Interface	MIPI DSI 2-LANS	°C	-
14	Operating Temperature	-20~70	°C	-
15	Storage Temperature	-30~80	°C	-

Note 1: Please refer to the mechanical drawing.

2. Pin Assignments

Pin No.	Name	Function
1-3	VDD	Power supply +5V.
4	GND	Power ground 0V.
5-6	NC	--
7	GND	Power ground 0V.
8	NC	--
9	GND	Power ground 0V.
10	NC/LCD_DISP	--
11	GND	Power ground 0V.
12	NC/BL_PWM	Backlight Enable.
13	/RESET	Active low reset to the LCM.
14	NC	--

15	GND	Power ground 0V.
16	NC/DATAN3	--
17	NC/DATAP3	--
18	GND	Power ground 0V.
19	NC/DATAN2	--
20	NC/DATAP2	--
21	GND	Power ground 0V.
22	DATAN1	Negative differential data1 for DSI.
23	DATAP1	Positive differential data1 for DSI.
24	GND	Power ground 0V.
25	DATAN0	Negative differential data0 for DSI.
26	DATAP0	Positive differential data0 for DSI.
27	GND	Power ground 0V.
28	CLOCKN	Negative differential clock for DSI.
29	CLOCKP	Positive differential clock for DSI.
30	GND	Power ground 0V.

3. DSI System Interface

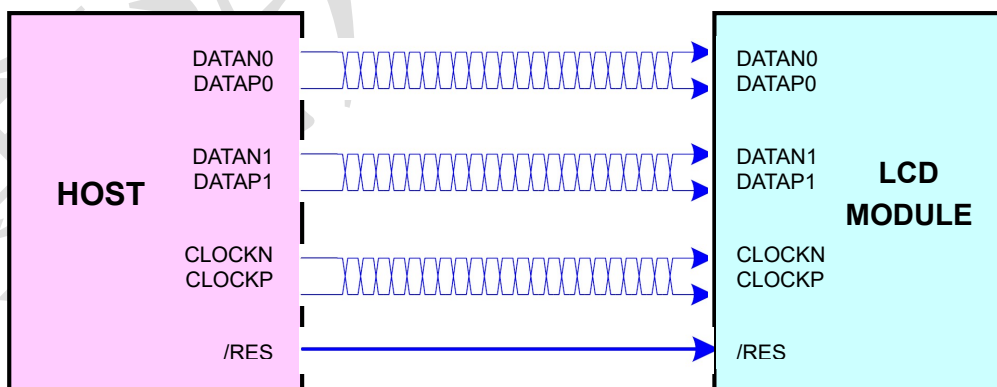

Figure 3-1 DSI System Interface

4. Absolute Maximum Ratings

Items	Symbol	MIN.	MAX.	Unit	Condition
Supply Voltage	VDD	-0.3	+12	V	VSS = 0V
Input Voltage	DSI input	-0.5	1.4	V	VSS = 0V
Operating Temperature	TOP	-20	+70	°C	No Condensation
Storage Temperature	Tst	-30	+80	°C	No Condensation

5. Electrical Characteristics

5.1 DC Characteristics

Parameter	Description	Min.	Typ.	Max.	Unit
VDD	Operating Voltage	4.8	5	12	V
VIL	Low Power logic 1 input voltage	880	-	-	mV
VIH	Low Power logic 0 input voltage	-	-	550	mV
VID	HS differential input voltage: Vdp- Vdn	70	200	270	mV
VIDT	HS differential input voltage threshold	-	-	50	mV
VIL-ULPS	Low Power receiver logic 0 voltage, ULP state	-	-	300	mV
VCMRX(DC)	Common-mode voltage HS receive mode	70	-	330	mV
Δ VCMRX(HF)	HS common-mode interference	-	-	100	mV
VIHHS	HS single-ended input high voltage	-	-	460	mV
VILHS	HS single-ended input low voltage	-40	-	-	mV
VTERM-EN	Single-ended threshold for HS termination enable	-	-	450	mV
ZID	Differential input impedance	80	100	124	Ω

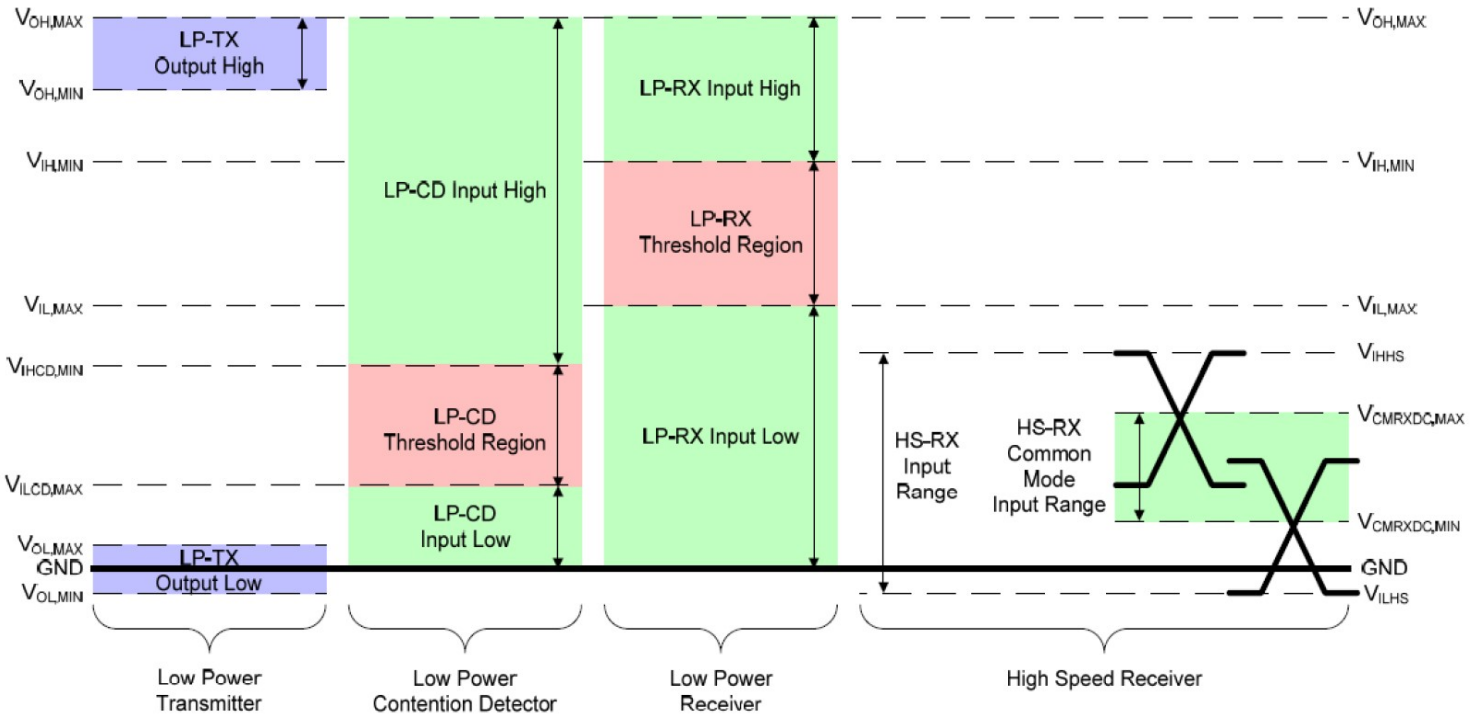

Figure 5-1 DSI signaling and Contention Voltage

5.2 Reset Pin Characteristics

Parameter	Conditions	Min.	Typ.	Max.	Unit
/RES input low level voltage	-	-0.3 V	-	0.3 x VDD	V
/RES input high level voltage	-	0.7 x VDD	-	VDD + 0.3	V
/RES output low level voltage	IOL= 2 mA	-	-	0.5	V
/RES input filtered pulse	-	-	-	75	ns
/RES input not filtered pulse	-	500	-	-	ns
/RES output pulse	-	20	-	-	µs

5.3 LED Backlight Characteristics

(Ta=+25°C)

Item	Symbol	Values			Unit	Remark
		Min.	Typ.	Max.		
Voltage for LED Backlight	VL	4.5	5	12	V	Note 1
Current for LED backlight	IL	30	40	50	mA	-
LED life time	-	20000	-	-	Hr	Note 2

Note 1: The Voltage for LED Backlight is defined at Ta=25°C and IL =40mA.

Note2: The “LED life time” is defined as the module brightness decrease to 50% original brightness that the ambient temperature is 25°C and IL =100mA. The LED lifetime could be decreased if operating IL is larger than 100 mA.

6. DSI Transmission Data Format

The LCM receives and interprets 24bpp(RGB888) DSI packets and translates to video stream. Packed Pixel Stream 24-Bit Format is a Long packet. It is used to transmit image data formatted as 24-bit pixels to a Video Mode display module. The packet consists of the DI byte, a two-byte WC, an ECC byte, a payload of length WC bytes and a two-byte Checksum. The pixel format is red (8 bits), green (8 bits) and blue (8 bits), in that order. Each color component occupies one byte in the pixel stream; no components are split across byte boundaries. Within a color component, the LSB is sent first, the MSB last.

With this format, pixel boundaries align with byte boundaries every three bytes. The total line width (displayed plus non-displayed pixels) should be a multiple of three bytes.

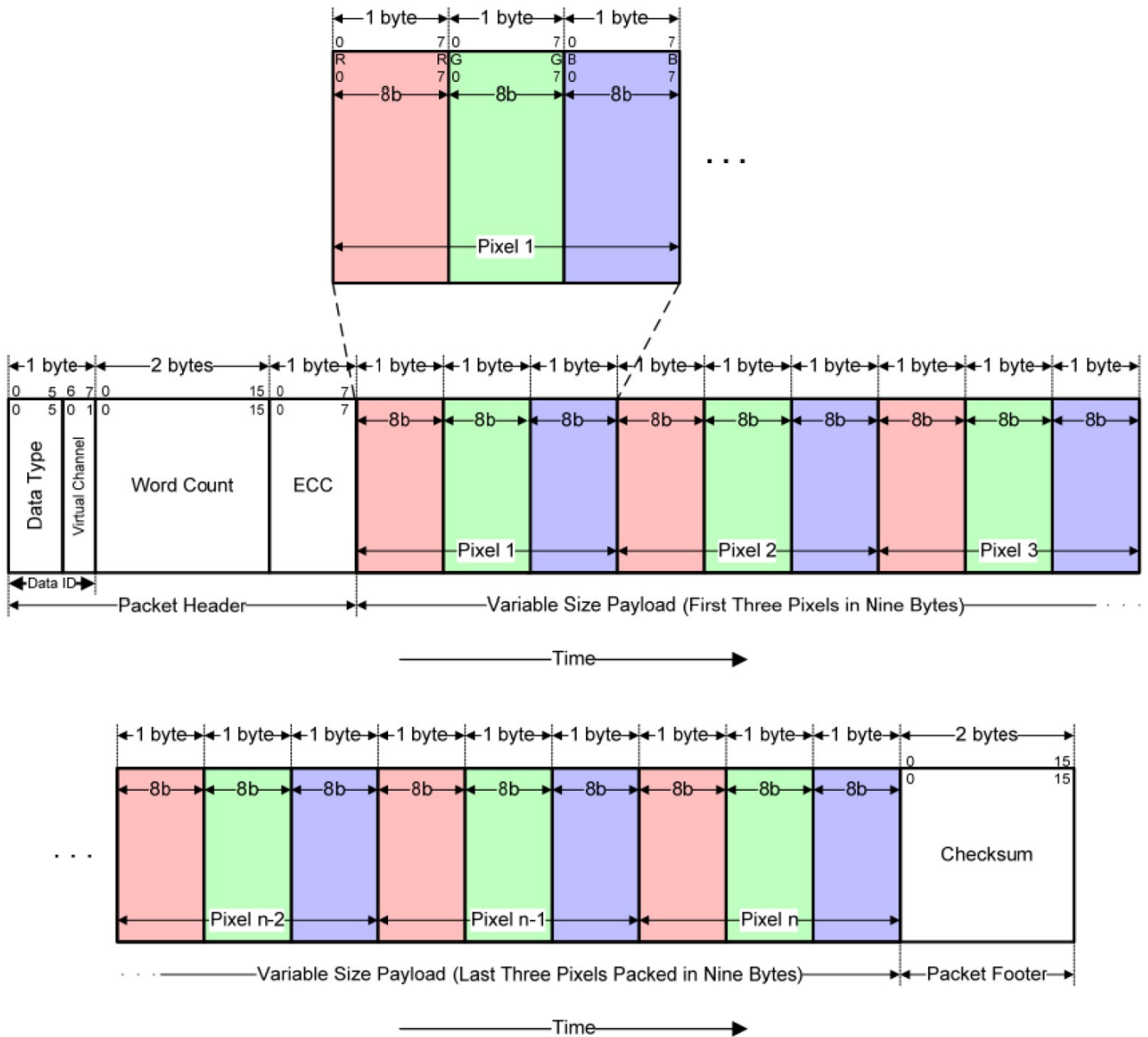

Figure 6-1 DSI RGB888 (24bpp) Color format, Long Packet

7. General DPI Timing

The Pixel clock (DCLK) is running all the time without stopping, it is used for entering VS, HS, DE and DB [23:0] states when there is a rising edge of the DCLK. The DCLK can not be used as the internal clock for other functions of the display module.

Vertical synchronization (Vsync) is used to tell when there is received a new frame of the display. This is low enable and its state is read to the display module by a rising edge of the DCLK signal. Horizontal synchronization (Hsync) is used to tell when there is received a new line of the frame. This is low enable and its state is read to the display module by a rising edge of the DCLK signal. DE (Data Enable) is used to tell when there is received RGB information that should be transferred on the display. This is a high enable and its state is read to the display module by a rising edge of

the DCLK signal. DB[23:0] are used to tell what is the information of the image that is transferred on the display (When DE= '0' (low) and there is a rising edge of DCLK). DB [23:0] can be '0' (low) or '1' (high). These lines are read by a rising edge of the DCLK signal.

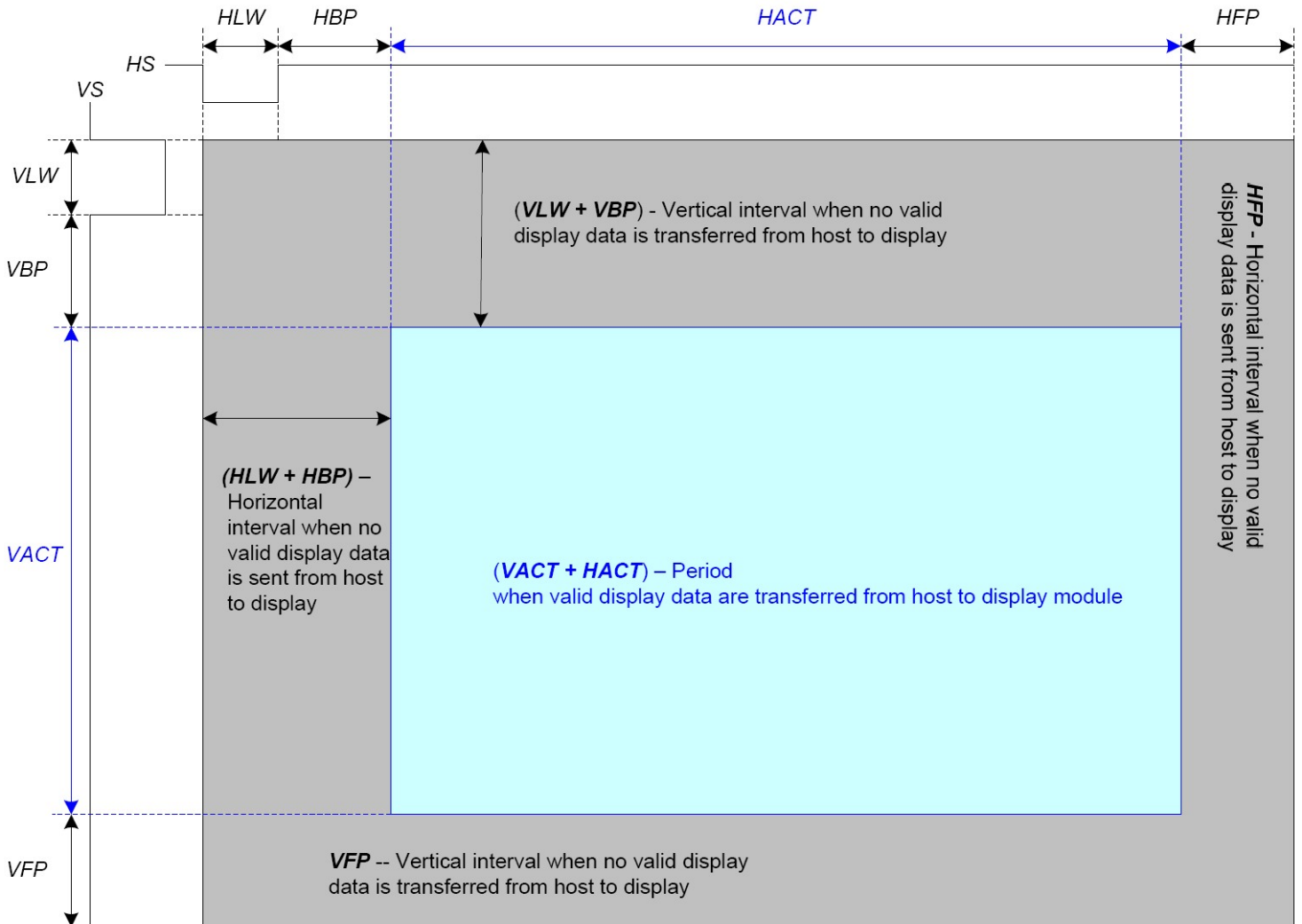

Figure 7-1 DRAM Access Area by RGB Interface

8. DPI Interface Timing

The timing chart of 24-bit DPI (RGB) interface mode is illustrated in Figure 8-1.

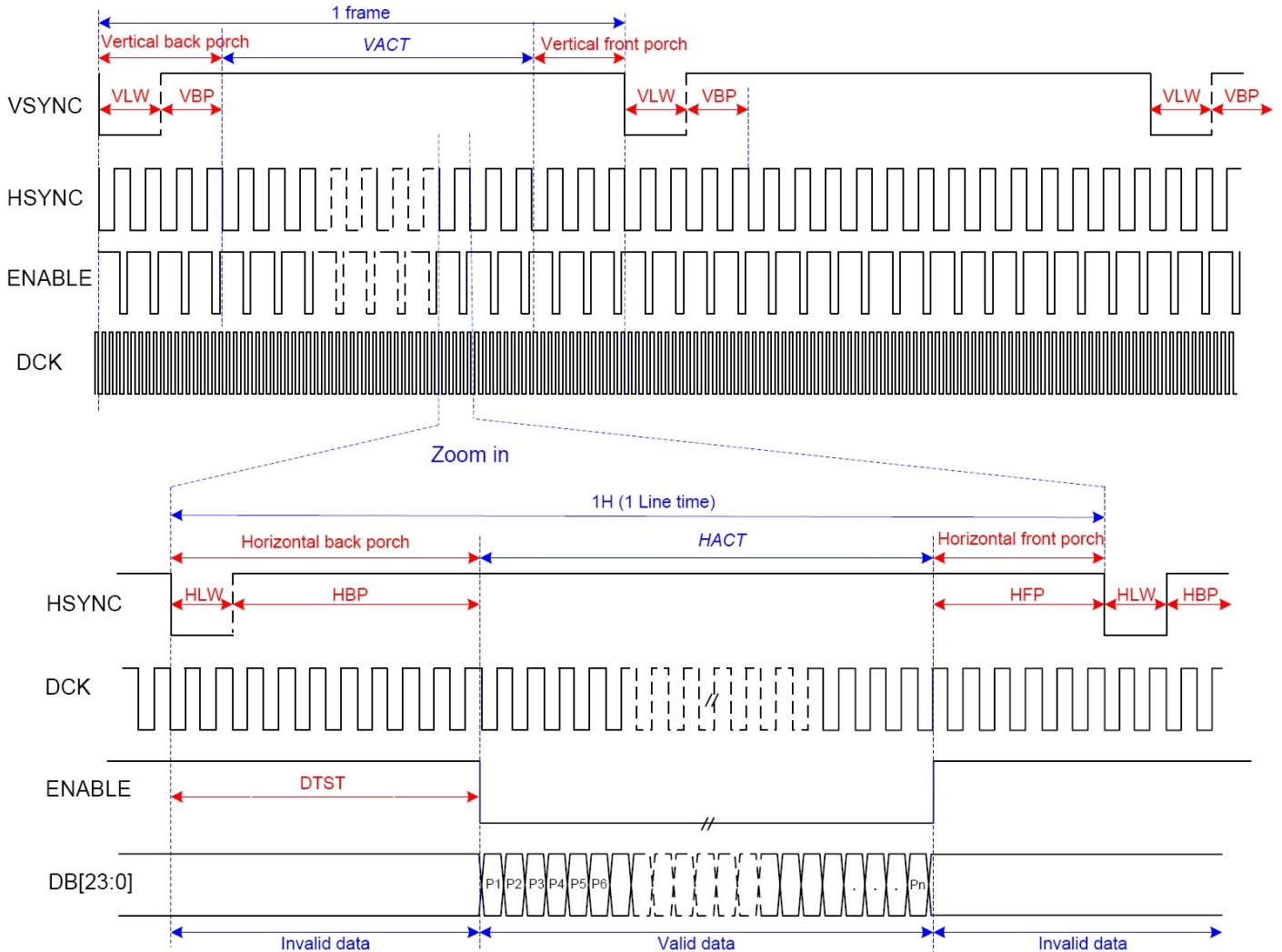

Figure 8-1 DPI Interface Timing

Note :

VLW -- VSYNC Low pulse Width

HLW -- HSYNC Low pulse Width

DTST -- Data Transfer Startup Time

Pn -- pixel 1, pixel 2..., pixel n.

Parameter	Symbols	Min.	Typ.	Max.	Units
Frame Rate	FR	50	60	80	fps
Dots Clock Frequency	DCLK	23	25	27	MHz
Horizontal Address	HACT	-	800	-	DCLK
Horizontal Front Porch	HFP	4	8	48	DCLK
Horizontal Low Pulse width	HLW	2	4	8	DCLK
Horizontal Back Porch	HBP	4	8	48	DCLK
Vertical Address	VACT	-	480	-	Line
Vertical Front Porch	VFP	4	8	12	Line
Vertical Low Pulse width	VLW	2	4	8	Line
Vertical Back Porch	VBP	4	8	12	Line

9. DSI Video Transmission Sequence

The LCM supports Non-Burst Mode with Sync Pulses, Non-Burst Mode with Sync Events and Burst mode.

9.1 Non-Burst Mode with Sync Pulses:

Enables the peripheral to accurately reconstruct original video timing, including sync pulse widths.

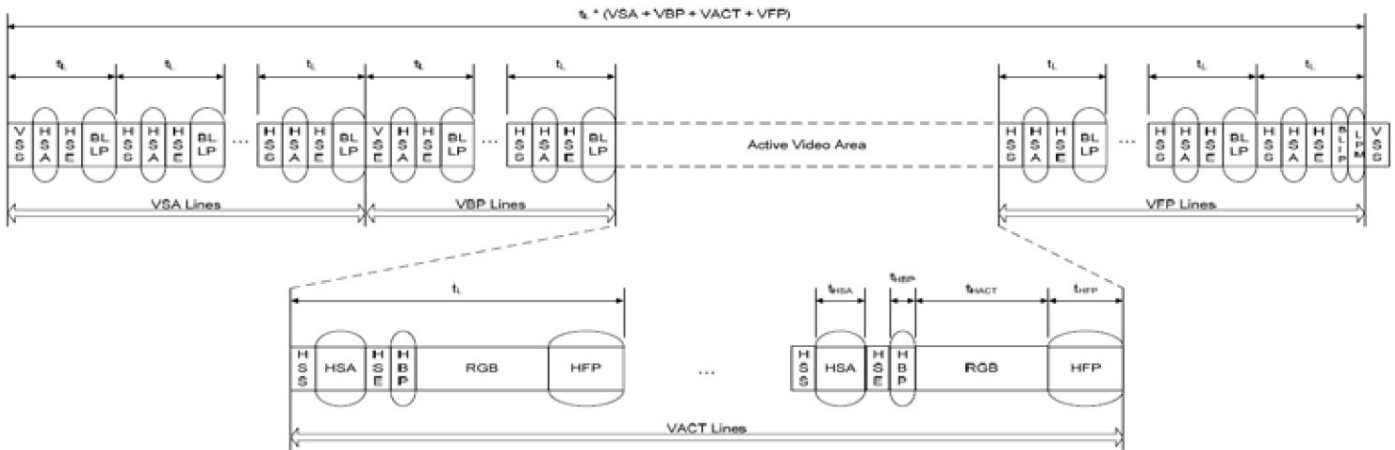

Figure 9-1 Non-Burst Mode with Sync Pulses

9.2 Non-Burst Mode with Sync Events:

Similar to above, but accurate reconstruction of sync pulse widths is not required, so a single Sync Event is substituted.

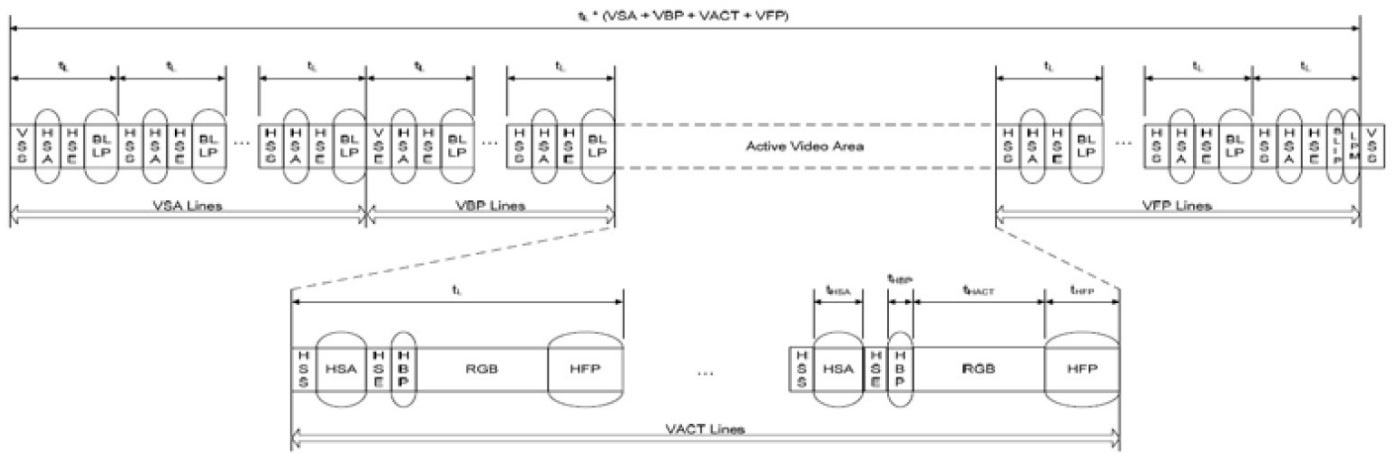

Figure 9-2 Non-Burst Mode with Sync Events

9.3 Burst mode:

The RGB pixel packets are time-compressed, leaving more time during a scan line for LP mode (saving power).

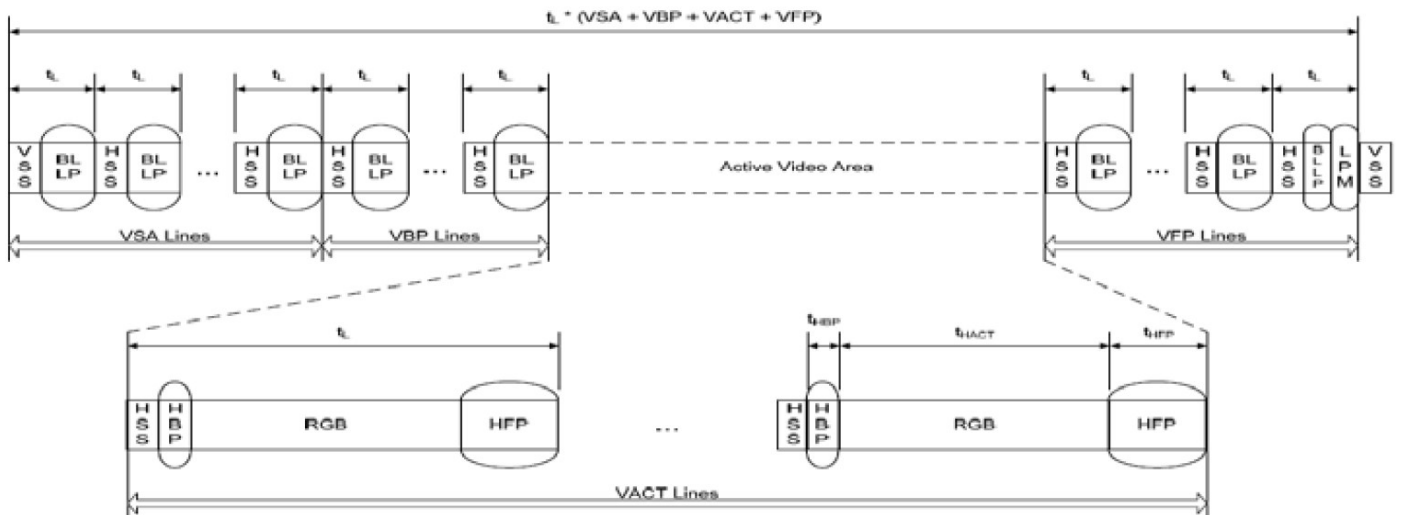

Figure 9-3 Burst mode

For all three sequences, the first line of a video frame shall start with a VSS packet, and all other lines start with VSE or HSS. The position of the synchronization packets in time is of utmost importance since this has a direct impact on the visual performance of the display panel; that is, the LVDS output video timing (HS-Horizontal sync and VS-Vertical sync) are generated based on the synchronization.

10. Optical Specifications

($T_a=+25^{\circ}\text{C}$, $V_{CI}=2.8\text{V}$, $V_{DD}=1.8\text{V}$, $I_B=46\text{mA}$)

Item	Symbol	Condition	Values			Unit	Remark	
			Min.	Typ.	Max.			
Viewing Angle Range	Left	θ_L	CR \geq 10	—	45	-	degree	Note 1,2
	Right	θ_R		—	45	-		
	Top	θ_T		—	50	-		
	Bottom	θ_B		—	20	-		
Response Time	$T_{on} + T_{off}$	Normal $\theta=\phi=0^{\circ}$	-	30	50	ms	Note 2,3	
Contrast Ratio	CR	Normal $\theta=\phi=0^{\circ}$	200	300	-	-	Note 2,4	
Luminance	L	Normal $\theta=\phi=0^{\circ}$	160	200	-	cd/m ²	Note 2,5	
Flicker	-	-	No Visible			-	Note 8	
Crosstalk	-	-	No Visible			-	Note 9	
Color Chromaticity (CIE1931)	White	W_x	Normal $\theta=\phi=0^{\circ}$	—	0.30	—	-	Note 2,6
		W_y		—	0.31	—		
	Red	R_x		—	0.59	—		
		R_y		—	0.32	—		
	Green	G_x		—	0.31	—		
		G_y		—	0.56	—		
	Blue	B_x		—	0.15	—		
		B_y		—	0.08	—		
Color Gamut	NTSC	CIE1931	-	58	-	%	-	
Luminance Uniformity	U_L	Normal $\theta=\phi=0^{\circ}$	—	80	-	%	Note 2,7	

Note 1: Definition of viewing angle

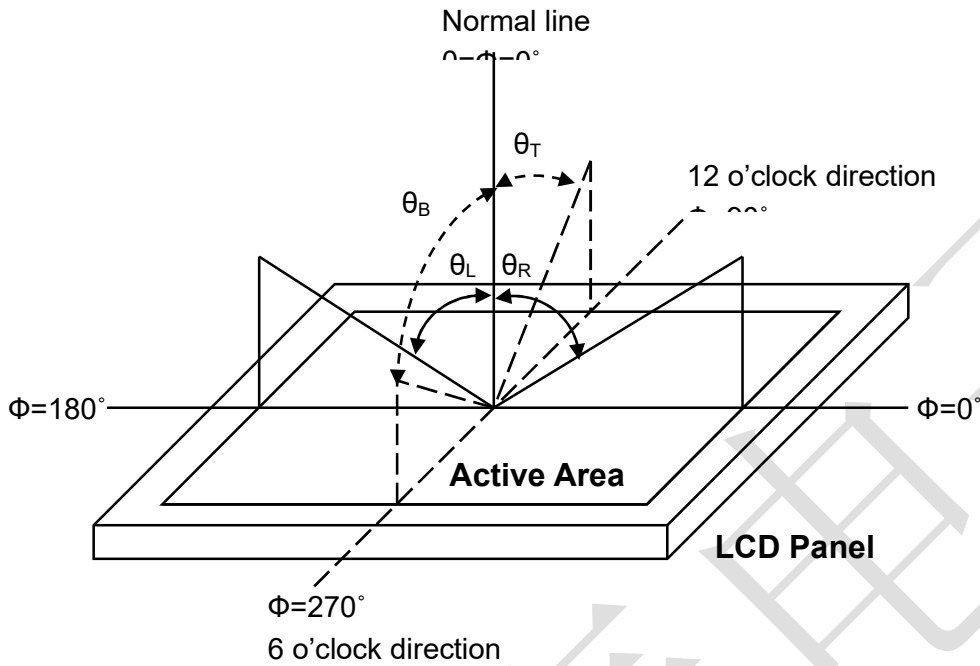

range

Fig. 1 Definition of viewing angle

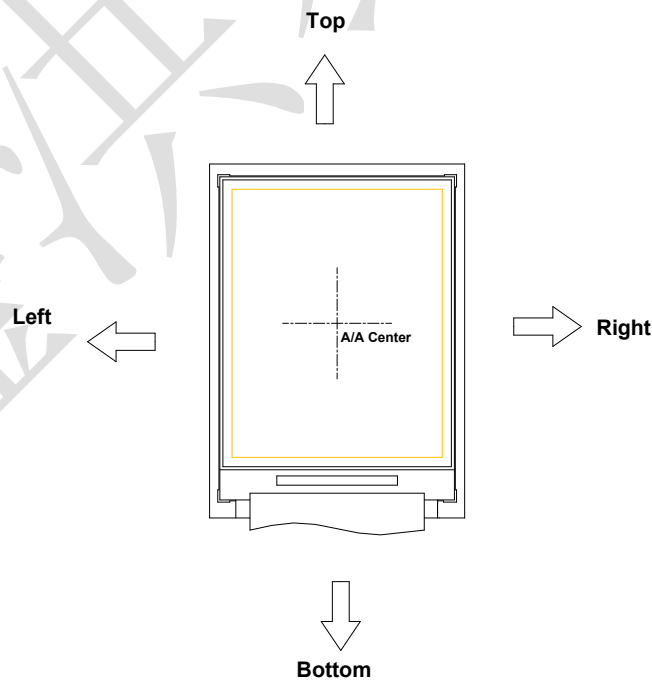

Fig. 2 Definition of viewing angle for display

Note 2: Definition of optical measurement system

The optical characteristics should be measured in a dark room with ambient temperature $T_a=+25$. The optical properties are measured at the center point of the LCD screen after 5 minutes operation. (Equipment: Photo detector TOPCON BM-5A or BM-7 /Field of view: 1° /Height: 500mm.)

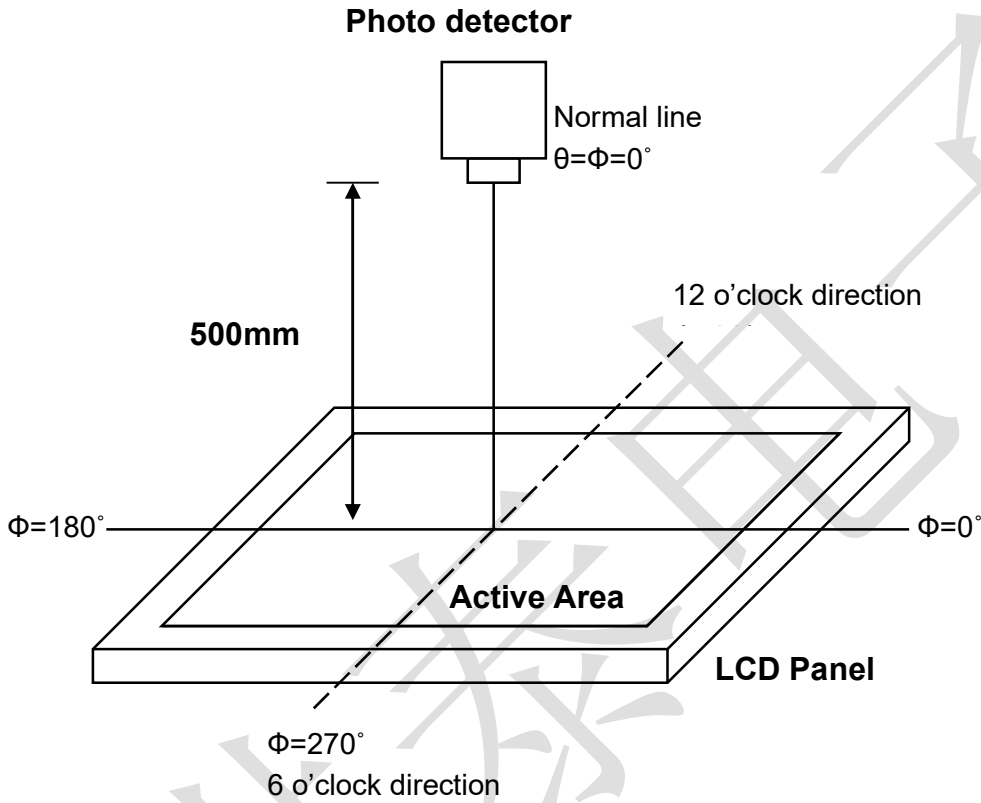

Fig. 10-1 Optical measurement system setup

Note 3: Definition of response time

The response time is defined as the LCD optical switching time interval between “White” state and “Black” state. Rise time (T_{on}) is the time between photo detector output intensity changed from 90% to 10%, and fall time (T_{off}) is the time between photo detector output intensity changed from 10% to 90%.

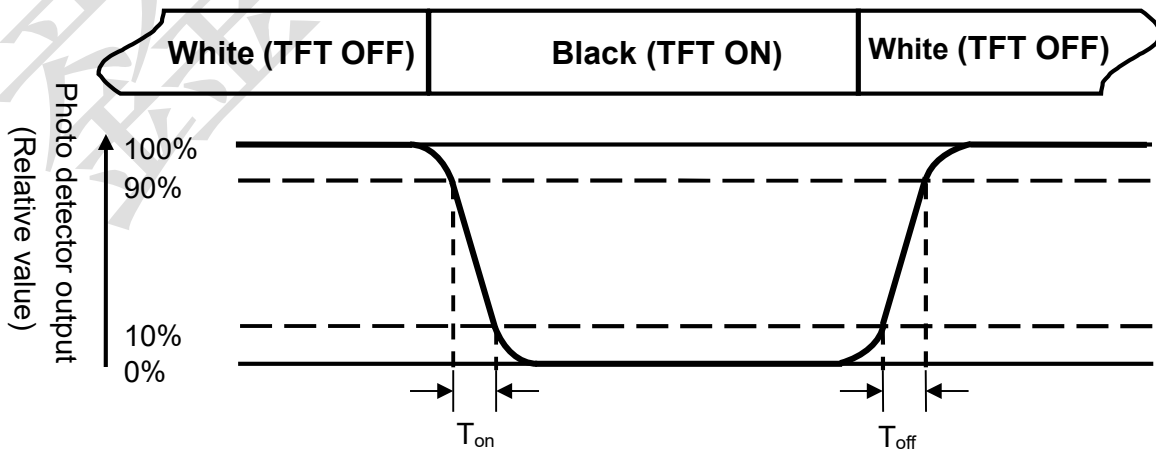

Fig. 10-2 Definition of response time Note 4: Definition of contrast ratio

$$\text{Contrast ratio (CR)} = \frac{\text{Luminance measured when LCD on the "White" state}}{\text{Luminance measured when LCD on the "Black" state}}$$

Note 5: Definition of luminance

Measured at the center area of the panel when LCD panel is driven at “white” state.

Note 6: Definition of color chromaticity (CIE1931)

Color coordinates measured at the center point of LCD when panel is driven at “White”, “Red”, “Green” and “Blue” state respectively.

Note 7: Definition of luminance uniformity

To test for uniformity, the tested area is divided into 3 rows and 3 columns. The measurement spot is placed at the center of each circle as below.

$$\text{Luminance Uniformity (U}_L\text{)} = \frac{L_{\min}}{L_{\max}}$$

L-----Active area length W----- Active area width

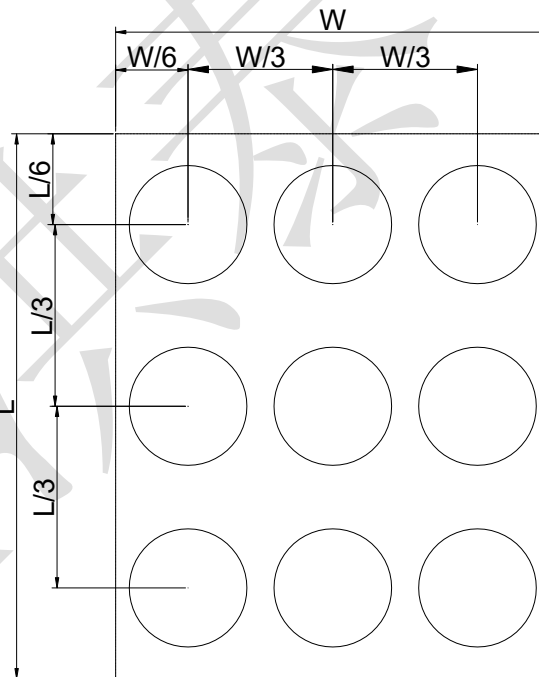

Fig. 10-3 Definition of luminance uniformity

L_{\max} : The measured maximum luminance of all measurement position.

L_{\min} : The measured minimum luminance of all measurement position.

Note 8: Definition of Flicker

Flicker is the pattern usually used to describe the visual sensation produced by a rapidly varying light intensity. There should be no visible flicker in normal direction of the display when the following figure are loaded.

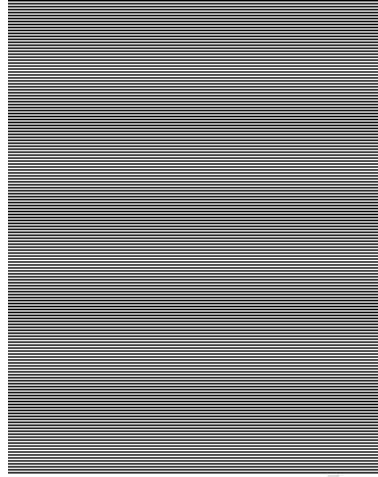

Fig.10-4 Flicker checker pattern

Note9: Definition of crosstalk

There should be no visible in normal direction of the display when the following figures are loaded.

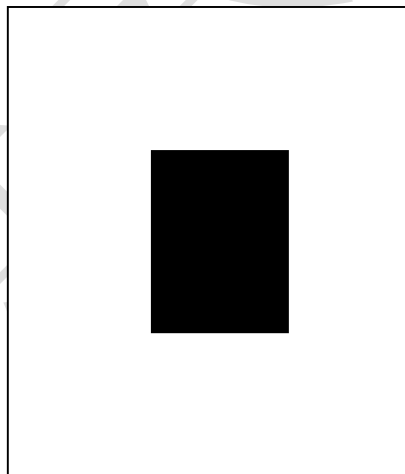

Fig.10-5 Crosstalk checker pattern

11. Reliability Test Items

Test Items	Test Conditions	Remark
High Temperature Storage	+80°C±3°C for 240 hours	-
Low Temperature Storage	-30°C±3°C for 240 hours	-
High Temperature Operation	+70°C±3°C for 240 hours	-
Low Temperature Operation	-20°C±3°C for 240 hours	-
High Temperature and Humidity Operation	+60°C±3°C, 90%±3%RH max. for 240 hours	-
Thermal Shock	-30°C/0.5h ~ +80°C/0.5h for a total 100 cycles, Start with cold temp and end with high temp	-
Vibration Test	Frequency range:10~55Hz Stoke:1.5mm Sweep:10Hz~55Hz~10Hz 2 hours for each direction of X. Y. Z. (6 hours for total)	-
Mechanical Shock	100G 6ms,±X, ±Y, ±Z 3 times for each direction	-
Package Vibration Test	Random Vibration : 0.015G ² /Hz from 5-200Hz, -6dB/Octave from 200-500Hz 1 hour for each direction of X. Y. Z. (3 hours for total)	-
Package Drop Test	Height :76cm(Weight ≤ 10kg); 60cm(Weight > 10kg) 1 corner, 3 edges, 6 surfaces	-
Electro Static Discharge	± 2KV, Human Body Mode, 100pF/1500Ω	-

Note1: During the display practical test under normal operation condition, there shall be no change, which may affect display function.

Note2: Before functional check, the test sample requires a 2 hours storage time at room temperature

12. Mechanical Drawing

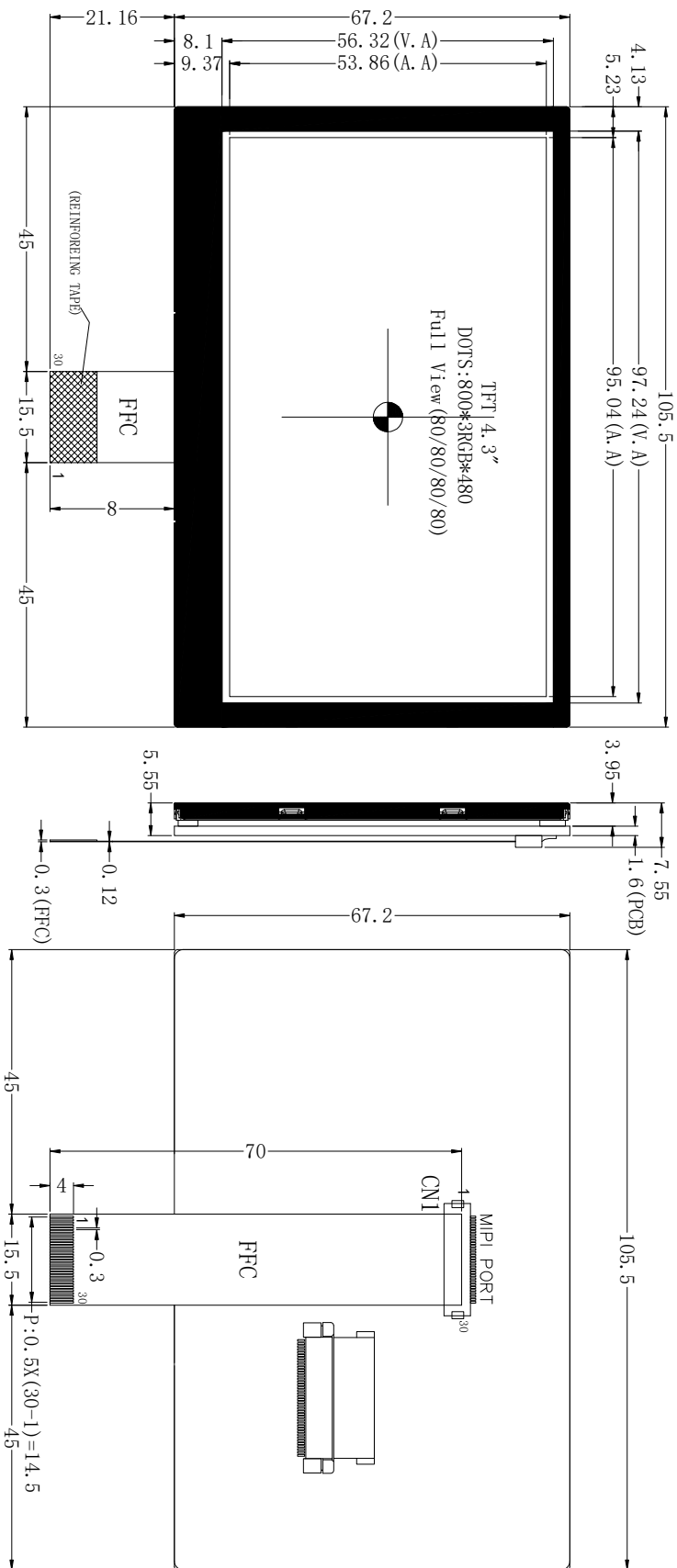

No.	Name	Description
1-3	VDD	POWER SUPPLY +5.0V.
4	GND	GROUND 0V.
5	NC	-
6	NC	-
7	GND	GROUND 0V.
8	NC	-
9	GND	GROUND 0V.
10	NC/LCD DISP	-
11	GND	GROUND 0V.
12	NC/BL PWM	-
13	LCD RST	ACTIVE LOW RESET TO THE LOG. (L=0V/H=3.3V)
14	NC	-
15	GND	GROUND 0V.
16	DSN	NEGATIVE DIFFERENTIAL DATA FOR DS1.
17	DSP	POSITIVE DIFFERENTIAL DATA FOR DS1.
18	GND	GROUND 0V.
19	DSN	NEGATIVE DIFFERENTIAL DATA FOR DS1.
20	DSP	POSITIVE DIFFERENTIAL DATA FOR DS1.
21	GND	GROUND 0V.
22	DIN	NEGATIVE DIFFERENTIAL DATA FOR DS1.
23	DIP	POSITIVE DIFFERENTIAL DATA FOR DS1.
24	GND	GROUND 0V.
25	DSN	NEGATIVE DIFFERENTIAL DATA FOR DS1.
26	DIP	POSITIVE DIFFERENTIAL DATA FOR DS1.
27	GND	GROUND 0V.
28	CLOCKN	NEGATIVE DIFFERENTIAL CLOCK FOR DS1.
29	CLOCKP	POSITIVE DIFFERENTIAL CLOCK FOR DS1.
30	GND	GROUND 0V.

HOT DISPLAY

Dwg Title: HTM-H043A10-MIP1-A06

EDC No.: Ver: A/0

Scale: 1:1 Unit: mm Tol.: ±0.3

Drawn: Checked: Date: 2023-06-08

*1. LCD DISPLAY TYPE	4.3" TFT/TRANSMISSIVE/NORMAL BLACK.
*2. VIEWING DIRECTION	ALL DIRECTION
*3. LCD DRIVER IC	MIP1-RGB Bridge
*4. OPERATING VOLTAGE	5V
*5. INPUT DATA	MIP1 DS1(4-LANS)
*6. OPERATING TEMP	-30°C~80°C
*7. STORAGE TEMP	-30°C~80°C
*8. BACKLIGHT	WHITE Vf=5V If=200mA
*9. Luminance	500 CD/m ²

D

A

B

C

D